



FUMK50000W/B
FUMK50010W/B



BOM - No. 12443335

Funköffnungsmelder
Installationsanleitung

Radio-controlled opening detector
Installation Guide

Détecteur d'ouverture sans fil
Instructions d'installation

Draadloze openingsmelder
Installatie-instructies

Radorilevatore di apertura
Guida di installazione

Trådløs åbningsmelder
Installationsvejledning

Radiowa czujka otwarcia
Instrukcja instalacji

D

GB

FR

NL

I

DK

PL

Vorwort

Sehr geehrte Kundin, sehr geehrter Kunde,

wir bedanken uns für den Kauf dieses Funk-Öffnungsmelders. Dieses Gerät ist nach dem heutigen Stand der Technik gebaut. Es erfüllt die Anforderungen der geltenden europäischen und nationalen Richtlinien.

"Hiermit erklärt ABUS Security-Center GmbH & Co. KG, dass sich das Gerät mit der Artikelnummer FUMK50000W/B; FUMK50010W/B in Übereinstimmung mit den grundlegenden Anforderungen und den einschlägigen Bestimmungen der Richtlinie 1999/5/EG befindet. Die Konformitätserklärung kann unter folgender Adresse bezogen werden:

ABUS Security-Center GmbH & Co. KG
Linker Kreuthweg 5
86444 Affing
GERMANY"



Achtung !

Beachten Sie die Anweisungen und Hinweise in dieser Anleitung! Sollten Sie sich nicht an diese Anleitung halten, erlischt Ihr Garantieanspruch! Für Folgeschäden wird keine Haftung übernommen! Das Produkt darf nicht geändert bzw. umgebaut werden.



Batteriewarnhinweise

Das Gerät wird über eine 3V Lithium Batterie mit Gleichspannung versorgt. Um eine lange Lebensdauer zu garantieren und Brände und Verletzungen zu vermeiden beachten Sie bitte die folgenden Hinweise:

- Entsorgen Sie die Batterie nicht über den Hausmüll
- Die Batterie darf keiner Wärmequelle oder Sonneneinstrahlung direkt ausgesetzt werden und an keinem Ort mit sehr hoher Temperatur aufbewahrt werden
- Die Batterie darf nicht verbrannt werden
- Die Batterie darf nicht mit Wasser in Berührung kommen
- Die Batterie darf nicht zerlegt, angestochen oder beschädigt werden
- Die Batteriekontakte dürfen nicht kurzgeschlossen werden
- Die Batterie darf nicht in die Hände von Kleinkindern gelangen
- Die Batterie ist nicht wieder aufladbar

1. Lieferumfang:

- 1 x Installationsanleitung
- 1 x Magnet
- 1 x Batterie CR2 3V Lithium
- 1 x Magnethalter
- 1 x Öffnungsmelder
- 2 x Senkkopfschrauben (Magnethalter)
- 2 x Linsenkopfschrauben (Melder)
- 4 x Magnet Abstandsplatten
- 2 x Melder Abstandsplatten
- 4 x Steckbrücken (Jumper) auf der Elektronik

3. Inbetriebnahme:

Öffnen Sie das Gehäuse, indem Sie die Schraube lösen und anschließend den Deckel entfernen.

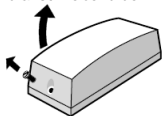

2. Technische Daten:

Spannungsversorgung:	3V Li/MnO ₂
Batterietyp:	CR2
Stromaufnahme:	0,03A
Frequenz:	868,6625 MHz / FM
Gewicht:	ca. 53g
Abmaße BxHxT mm:	33x89x29
Batterielaufzeit:	bis 36 Monate
Umweltklasse:	I (-10-+55°C)
Sicherheitsgrad:	II
INCERT-Nr.:	C0160194
Gehäusematerial.:	ABS



Achtung !

Beachten Sie die Polung!

Setzen Sie die Batterie in den Funköffnungsmelder ein.

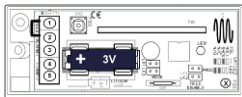

4. Signal LED

Betriebszustand	Signal
Betriebsmodus	Kein Signal
Senden / Programmier Modus IR	4 x Blinken
Programmier Modus Melder intern	Kontinuierliches Blinken

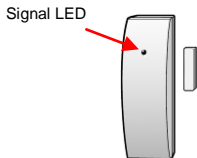

D

5. LED aktivieren

Stecken Sie einen Jumper auf LK1 und LK3.
Schließen Sie **LK4** mit einem Jumper kurz, bis die LED kontinuierlich blinkt. Danach entfernen Sie diesen wieder, die LED ist jetzt aktiviert. Stellen Sie die ursprüngliche Position der Jumper wieder her.

LED - ON

Jumper	
LK1	■
LK2	□ □
LK3	■
LK4	□ □



6. LED deaktivieren

Stecken Sie einen Jumper auf LK1. Schließen Sie **LK4** mit einem Jumper kurz, bis die LED kontinuierlich blinkt. Danach entfernen Sie diesen wieder, die LED ist jetzt deaktiviert. Stellen Sie die ursprüngliche Position der Jumper wieder her.

LED - OFF

Jumper	
LK1	■
LK2	□ □
LK3	□ □
LK4	□ □

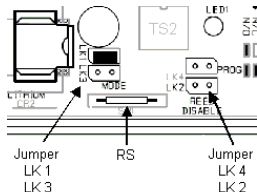

7. Einlernen der Zonen:

Stellen Sie sicher, dass sich die **Secvest** (Empfänger) jeweils im Einlernmodus befindet. Verwenden Sie ein **Funk - Universalmodul** (Funkerweiterung), dann halten Sie die Signal LED „SL“ des Melders max. 50mm über den IR Empfänger und lernen Sie wie unten beschrieben die Zonen ein



Auf den letzten Seiten befinden sich die möglichen Konfigurationen der einzelnen Zonen. Sie können diesen Funkmagnetkontakt auch als Funkmodul nutzen.

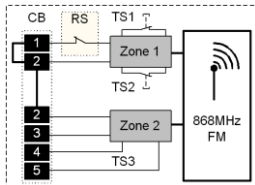

D

8. Einlernen der Zone 1

Halten Sie den Wandabrisskontakt „TS2“, im ausgebauten Zustand auch den Deckelkontakt „TS1“ gedrückt.

Öffnen Sie einen dieser Kontakte, bis der Empfänger den Empfang bestätigt.

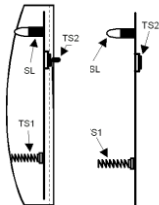

9. Einlernen der Zone 2

(wenn erforderlich)

Schließen Sie den Anschluss „TAMP“ mit einer Drahtbrücke an der Anschlussklemme Kontakt 4 und 5.

Öffnen und schließen Sie die Verbindung „TAMP“, bis der Empfänger den Empfang bestätigt.

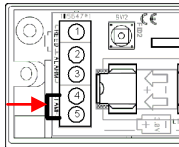

Achtung!

10. Montieren Sie den Melder:

- **nicht** auf oder in der Nähe von Metallflächen!
- **nicht** unter 1m zu Gas-, Wasser- und Stromleitungen!
- **nicht** in der Nähe von elektrischen Geräten z.B., Computer, Kopierer oder anderen Sendern!

11. Reichweite:

Die Reichweite ist abhängig von den Umgebungsbedingungen. Befestigen Sie deshalb den Melder probeweise mit doppelseitigem Klebeband und lösen Sie zum Test einen Alarm aus. Wurde dieses Signal von der **Secvest** nicht empfangen, testen Sie den Melder an einer anderen Stelle. Die Signalstärke sollte den **Wert 3** nicht unterschreiten. Überprüfung mit der **Secvest**: Gehen Sie in den Errichtermodus → Test → Meldersignal

12. Montageort:

Optimaler Montageort für den Funköffnungsmelder ist die obere Ecke Ihres Fenster-/Tür-Rahmens. Achten Sie darauf, dass Sie den Melder auf einer ebenen Fläche installieren, damit der Wandabrisskontakt TS2 (siehe Einlernen Zone 1) schaltet.



D

Anzeige: **Secvest**

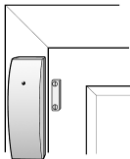

13. Montage:

Entfernen Sie die Platine aus dem Gehäuse. Schraube „MS“ lösen, die Platine herausheben.

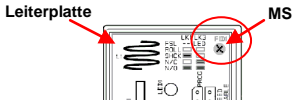

Befestigen Sie den Melder und den Magnethalter mittig zur Markierung „3“ mit max.10 mm Abstand.

Danach verwenden Sie die Bodenplatte des Melders und des Magnethalters um die Befestigungslöcher 1, 4 und 6, 7 zu markieren

Verwenden Sie die Linsenkopfschrauben „A“ für den **Melder** und die Senkkopfschrauben „B“ für den **Magnethalter**.

Achten Sie darauf, dass sich der Wandabrisskontakt „2“ nach innen bewegt.

Kabelöffnung „5“ für externe Melder, max. 10 Meter Anschlusskabel.

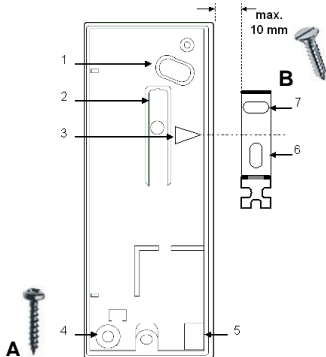

14. Konfigurationen :

Abkürzungen	Beschreibung	Abkürzungen	Beschreibung
CB	Anschlussklemme	TS1 - 2	Interne Sabotagekontakte
RS	Reed Schalter	eTS3	Externer Sabotagekontakt
NC	Normal geschlossen	eS1 - 2	Externe Schaltkontakte
NO	Normal offen		

D



Verwenden Sie nur die Zone 2 des Melders, so sind die Internen Sabotagekontakte TS1-2 deaktiviert.

Fig.1

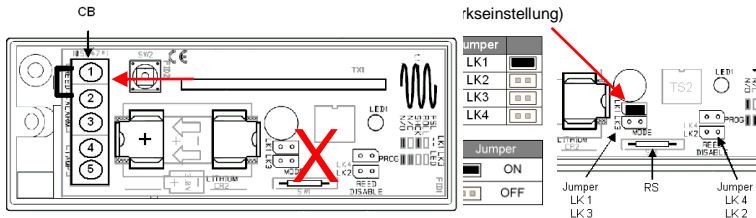

Preface

Dear customers,

Many thanks for your purchase of this wireless opening detector. This device is built according to state-of-the-art technology. It complies with current domestic and European regulations.

ABUS Security-Center GmbH & Co. KG, hereby declares that the device with item number FUMK50000W/B; FUMK50010W/B complies with the essential requirements and other relevant provisions of Directive 1999/5/EG. The declaration of conformity can be obtained from the following address:

ABUS Security-Center GmbH & Co. KG
Linker Kreuthweg 5
86444 Affing
GERMANY"

GB



Important!

Pay attention to the notes and instructions in these operating instructions! If you do not follow these instructions, your guarantee claim becomes invalid! No liability can be accepted for resulting damages!

The product may not be changed or modified in any way.



Battery warning!

The device is supplied with direct current from a 3 V lithium battery. To guarantee a long working life and avoid fire and injury, please note the following:

- Do not dispose of the battery in domestic waste.
- Do not expose the battery to direct sunlight or sources of heat.
- Do not store the battery under high temperatures.
- The battery must not be burned.
- The battery must not come into contact with water.
- The battery must not be dismantled, pierced or otherwise damaged.
- The battery contacts must not be short-circuited.
- The battery must be kept away from small children.
- The battery cannot be recharged.

1. Scope of delivery

- 1 x installation instructions
- 1 x magnet
- 1 x CR2 3 V lithium battery
- 1 x magnet holder
- 1 x opening detector
- 2 x countersunk screws (magnet holder)
- 2 x rounded head screws (detector)
- 4 x magnet spacers
- 2 x detector spacers
- 4 x jumpers

3. Putting into operation

Open the housing by loosening the screw and then removing the cover.

2. Technical data

Power supply:	3 V Li/MnO ₂
Battery type:	CR2
Power consumption:	0.03 A
Frequency:	868.6625 MHz/FM
Weight:	ca. 53 g
Dimensions (WxHxD in mm):	33x89x29
Battery life:	Up to 36 months
Environment class:	I (-10 to +55 °C)
Security level:	II
INCERT no.:	C0160194
Housing material:	ABS



Important!

Check for correct polarity!

Insert the battery into the wireless opening detector.

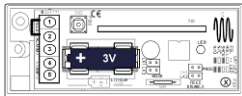

4. Signal LEDs

Operating state	Signal
Operating mode	No signal
Transmit / IR programming mode	4 x flash
Programming mode for internal detectors	Continuous flashing

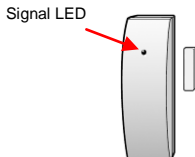

5. Activating the LED

Attach a jumper to contacts LK1 and LK3. Short-circuit the **LK4** contact with a jumper until the LED flashes continuously. Remove this again. The LED is now activated. Restore the original position of the jumper.

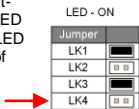

6. Deactivating the LED

Attach a jumper to contact LK1. Short-circuit the **LK4** contact with a jumper until the LED flashes continuously. Remove this again. The LED is now deactivated. Restore the original position of the jumper.

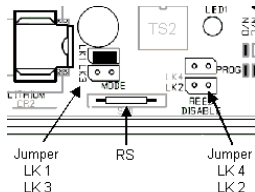
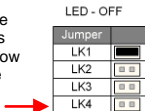

7. Training the zones

Ensure that the **Secvest** (receiver) is in learning mode. Using a **wireless accessory module** (wireless extension), hold the “**SL**” signal LED of the detector at a maximum of 50 mm above the IR receiver. Train the zones as described below.



The possible configurations of the individual zones can be found on the previous pages. You can also use this wireless magnet contact as a wireless module.

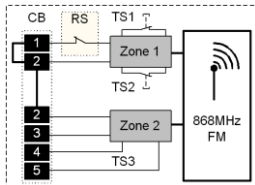

GB

8. Training zone 1

Keep the “**TS2**” anti-removal wall contact pressed. When deinstalled, also keep the “**TS1**” cover contact pressed.

Open one of these contacts until successful reception is confirmed.

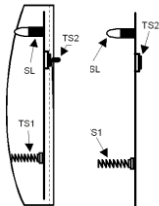

9. Training zone 2

(if necessary)

Connect the “**TAMP**” contact with a jumper on the terminal connector strip of contacts 4 and 5.

Open and close the “**TAMP**” connection until successful reception is confirmed.

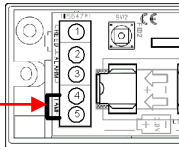

Important!

10. Attaching the detector

- **Do not** attach on or near metal surfaces!
- **Do not** attach within 1 metre of gas, water or power lines!
- **Do not** attach near electronic devices (e.g. computers, photocopiers or other detectors)!

11. Range

The range is dependent on the surrounding conditions. Therefore, use double-sided adhesive tape to fix the detector temporarily in different locations and test it by triggering an alarm. If this signal is not detected by the **Secvest**, move the detector to a new position. The signal strength should not fall below 3. Testing using the **Secvest**: Installer menu → Test → Detector signal

12. Installation location

The best place to install the wireless opening detector is the upper corner of the window/door frame. Ensure that the detector is installed on a flat surface so the TS2 contact switches correctly (see "Training zone 1").



Displays: **Secvest**

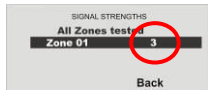

GB

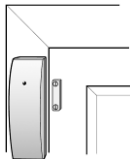

13. Installation

Remove the PCB from the housing. Loosen the “MS” screw and lift out the PCB.

PCB

MS



Fasten the detector and magnet holder centrally to the “3” marking with a maximum spacing of 10 mm.

Use the base plate of the detector and the magnet holder to mark the fastening holes 1, 4, 6 and 7.

Use the rounded head screw “A” for the **detector** and the countersunk screw “B” for the **magnet holder**.

Ensure that the anti-removal wall contact “2” can be moved inwards.

Cable opening “5” for external detectors with a connection cable of max. 10 metres.

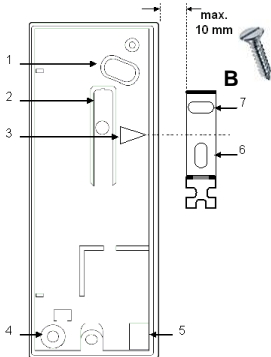

GB

14. Configuration

Abbreviations	Description	Abbreviations	Description
CB	Terminal connector strip	TS1 - 2	Internal tamper contacts
RS	Reed switch	eTS3	External tamper contact
NC	Normal closed contact	eS1 - 2	External switch contacts
NO	Normal open contact		



Only use zone 2 of the detector, as the internal tamper contacts TS1-2 are deactivated in this way.

GB

Fig. 1

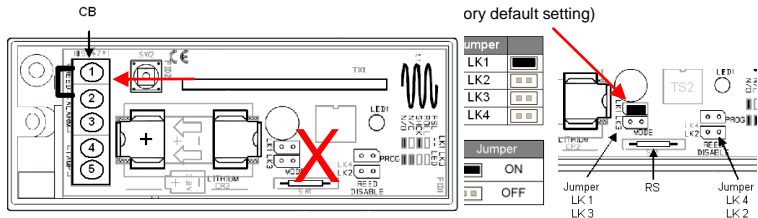

Préface

Chère cliente, cher client,

Nous vous remercions d'avoir porté votre choix sur ce détecteur d'ouverture sans fil. Le présent produit fait appel à une technologie de pointe. Il est conforme aux exigences des directives européennes et nationales en vigueur.

« ABUS Security-Center GmbH & Co. KG déclare par la présente que la référence FUMK50000W/B; FUMK50010W/B est conforme aux exigences fondamentales et aux autres prescriptions en vigueur des/de la directive 1999/5/EG. La déclaration de conformité est disponible à l'adresse suivante:

ABUS Security-Center GmbH & Co. KG
Linker Kreuthweg 5
86444 Affing
GERMANY"

F



Attention !

Tenir compte des instructions et des consignes de la présente notice ! Le non-respect des présentes instructions entraîne la déchéance de la garantie ! La société ne saurait être tenue responsable des dommages indirects !

Une modification ou une transformation de la structure d'une quelconque partie de ce produit n'est pas autorisée.



Avertissements concernant la pile

L'appareil est alimenté en tension continue par une pile au lithium de 3 V. Pour assurer une vie longue durée à la pile et éviter les incendies et les préjudices corporels, veuillez tenir compte des consignes ci-après :

- Ne pas jeter la pile dans les ordures ménagères.
- La pile ne doit être ni directement exposée à une source de chaleur ou un rayonnement solaire ni conservée dans un lieu à très haute température.
- Ne pas faire brûler la pile.
- La pile ne doit pas entrer en contact avec de l'eau.
- Elle ne doit être ni démontée, ni percée, ni endommagée.
- Les contacts de la pile ne doivent pas être court-circuités.
- Mettre la pile hors de portée des enfants en bas-âge.
- La pile n'est pas rechargeable.

1. Contenu de la livraison :

- 1 x instructions d'installation
- 1 aimant
- 1 x pile CR2 3 V au lithium
- 1 support magnétique
- 1 détecteur d'ouverture
- 2 vis à tête noyée (support magnétique)
- 2 vis à tête cylindrique (détecteur)
- 4 plaques de calage de l'aimant
- 2 plaques de calage du détecteur
- 4 straps enfichables (cavaliers) sur l'électronique

3. Mise en service :

Ouvrir le boîtier en desserrant la vis, puis en retirant le couvercle.

2. Fiche technique :

Alimentation :	3V Li/MnO2
Type de pile :	CR2
Consommation :	0,03 A
Fréquence :	868,6625 MHz/FM
Poids :	env. 53 g
Dimensions LxHxP mm :	33x89x29
Durée de service de la pile :	36 mois maxi.
Classe environnementale :	I (-10+55 °C)
Niveau de sécurité :	II
N° INCERT :	C0160194
Boîtier :	ABS



Attention !

Faire attention à la polarité !

Introduisez la pile dans le détecteur d'ouverture sans fil.

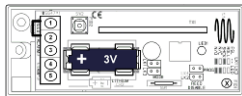

4. DEL de signalisation:

Etat de fonctionnement	Signal
Mode de fonctionnement	Aucun signal
Emission / Mode de programmation IR	4 clignotements
Mode de programmation détecteur interne	Clignotement continu

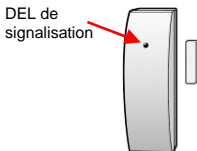

5. Activation de DEL :

Enfichez un cavalier sur LK1 et LK3. Shuntez **LK4** à l'aide d'un cavalier jusqu'à ce que la DEL clignote continuellement. Retirez-le ensuite. La DEL est maintenant active. Remettez le cavalier sur sa position d'origine.

LED - ON

Jumper	
LK1	■
LK2	□ □
LK3	■
LK4	□ □



6. Désactivation de LED :

Enfichez un cavalier sur LK1. Shuntez **LK4** à l'aide d'un cavalier jusqu'à ce que la DEL clignote continuellement. Retirez-le ensuite. La DEL est maintenant désactivée. Remettez le cavalier sur sa position d'origine.

LED - OFF

Jumper	
LK1	■
LK2	□ □
LK3	□ □
LK4	□ □

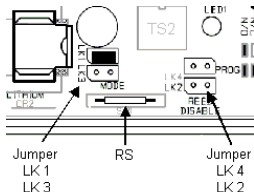

7. Apprentissage des zones :

Assurez-vous que la **Secvest** (récepteur) soit à chaque fois en mode d'apprentissage. Utilisez un **module universel sans fil** (extension radio), puis tenez la DEL de signalisation « **SL** » du détecteur à 50 mm maxi. au-dessus du récepteur IR et procédez à l'apprentissage des zones comme décrit ci-après.



Aux dernières pages, vous trouverez les configurations possibles des diverses zones. Ce contact magnétique sans fil peut également être utilisé en tant que module radio.

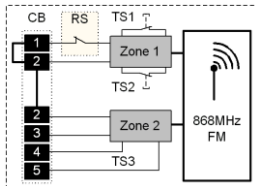

8. Apprentissage de la zone 1 :

Maintenez le contact anti-arrachement mural « **TS2** », à l'état démonté également le contact de couvercle « **TS1** » enfoncés.

Ouvrez l'un de ces contacts jusqu'à ce que le récepteur accuse réception.

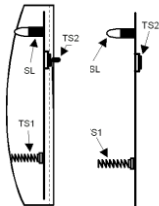

9. Apprentissage de la zone 2:

(si nécessaire)

Reliez la borne « **TAMP** » à la borne contact 4 et 5 à l'aide d'un cavalier.

Ouvrez et fermez la connexion « **TAMP** », jusqu'à ce que le récepteur confirme.

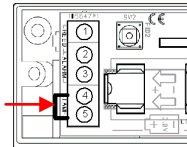

Attention !

10. Ne pas monter le détecteur :

- sur ou à proximité de surfaces métalliques !
- à moins de 1 m de conduites de gaz, d'eau ou de lignes de courant !
- à proximité d'appareils électriques, tels que des ordinateurs, des photocopieurs ou autres émetteurs !

11. Portée :

La portée dépend des conditions ambiantes. Fixez donc le détecteur à titre d'essai à l'aide de ruban adhésif double face et déclenchez une alarme d'essai. Si ce signal n'a pas été reçu par la **Secvest**, testez le détecteur à un autre endroit. L'intensité du signal ne doit pas être inférieure à la **valeur 3**.
Vérification avec la **Secvest**: Passez en mode installateur → Test → Portée Radio

12. Site de montage :

Le coin supérieur de votre fenêtre/encadrement de porte est un site de montage optimal du détecteur d'ouverture de porte. Veillez à installer le détecteur sur une surface plane, pour que le contact anti-arrachement murale TS2 commute (voir Apprentissage de la zone 1).



Affichage : **Secvest**

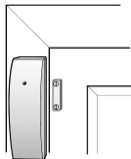

13. Montage :

Retirez la platine du boîtier. Desserrez la vis « **MS** » et retirez la platine en la soulevant.

Carte de circuits imprimés

MS

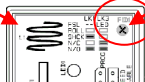

Fixez le détecteur et le support magnétique en les centrant par rapport au repère « 3 » et à 10 mm de distance maxi.

Utilisez ensuite l'embase du détecteur et du support magnétique pour le repérage des trous de fixation 1, 4 et 6, 7.

Utilisez les vis à tête cylindrique « **A** » pour le **détecteur** et les vis à tête noyée « **B** » pour le **support magnétique**.

Veillez à ce que le contact anti-arrachement mural « **2** » se déplace vers l'intérieur.

Passer-câble « **5** » pour détecteur externe, câble de raccordement de 10 mètres maxi.

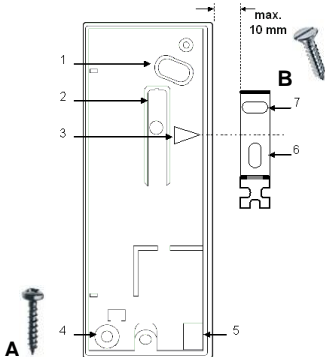

F

14. Configurations :

Abréviations	Description	Abréviations	Description
CB	Borne de raccordement	TS1 - 2	Contacts anti-sabotage internes
RS	Contact à lames souples	eTS3	Contact anti-sabotage externe
NC	Normalement fermé	eS1 - 2	Contacts de commutation externes
NO	Normalement ouvert		



Si vous n'utilisez que la zone 2 du détecteur, les contacts anti-sabotage internes TS1-2 sont désactivés.

Fig. 1

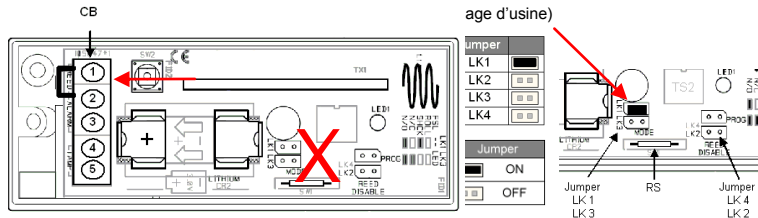

Voorwoord

Geachte klant,

Wij bedanken u voor de aankoop van deze draadloze openingsmelder. Dit apparaat is met de allernieuwste techniek gebouwd. Het voldoet aan de eisen van de geldende Europese en nationale richtlijnen.

„Hiermee verklaart ABUS Security-Center GmbH & Co. KG, dat het apparaat met bestelnummer FUMK50000W/B; FUMK50010W/B in overeenstemming is met de essentiële eisen en overige desbetreffende bepalingen van de richtlijn 1999/5/EG. De conformiteitsverklaring kan worden aangevraagd onder het volgende adres:

ABUS Security-Center GmbH & Co. KG
Linker Kreuthweg 5
86444 Affing
GERMANY"



Let op!

Neem de instructies en opmerkingen in deze handleiding in acht! Als u zich niet aan deze handleiding houdt, vervalt uw aanspraak op garantie! We aanvaarden geen aansprakelijkheid voor gevolgschade!

Het product mag niet gewijzigd of omgebouwd worden.



Waarschuwingen i.v.m. de batterij

Het toestel wordt door een 3V lithium batterij van gelijkspanning voorzien. Om een lange levensduur te garanderen en brand en verwondingen te voorkomen, dient u de volgende aanwijzingen in acht te nemen:

- Voer de batterij niet via het huisvuil af.
- De batterij mag niet direct aan een warmtebron of zonlicht blootgesteld worden en mag niet op een plaats met heel hoge temperatuur bewaard worden
- De batterij mag niet worden verbrand.
- De batterij mag niet met water in aanraking komen.
- De batterij mag niet uiteen gehaald worden, er mag niet in worden geprikt en ze mag niet beschadigd worden.
- De batterijcontacten mogen niet kortgesloten worden.
- De batterij mag niet in de handen van kleine kinderen terecht komen.
- De batterij is niet herlaadbaar.

1. Leveromvang:

- 1 x installatie-instructies
- 1 x magneet
- 1 x batterij CR2 3 V lithium
- 1 x magneethouder
- 1 x openingsmelder
- 2 x platkopschroeven (magneethouder)
- 2 x lenskopschroeven (melder)
- 4 x magneet afstandsplaten
- 2 x melder afstandsplaten
- 4 x geleiderbruggen (jumper) op de elektronica

3. Ingebruikneming:

Open het huis door de schroef los te draaien en vervolgens het deksel te verwijderen.

2. Technische gegevens:

Spanningsvoeding:	3V Li/MnO ₂
Batterijtype:	CR2
Stroomopname:	0,03 A
Frequentie:	868,6625 MHz / FM
Gewicht:	ca. 53 g
Afmetingen b x h x d mm:	33x89x29
Batterijlooptijd:	tot 36 maanden
Milieuklasse:	I (-10 - +55 °C)
Veiligheidsgraad:	II
INCERT-nr.:	C0160194
Materiaal van het huis:	ABS



Let op!

Let op de juiste polen!

Plaats de batterij in de draadloze openingsmelder.

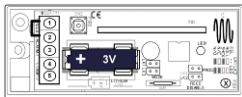

4. Signaal-LED

Bedrijfstoestand	Signaal
Bedrijfsmodus	Geen signaal
Zenden / programmeermodus IR	4 x knipperen
Programmeermodus melder intern	Permanent knipperen

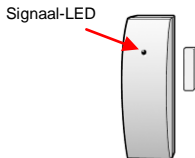

5. LED activeren

Steek een jumper op LK1 en LK3. Sluit **LK4** met een jumper kort tot de LED permanent knippert. Daarna verwijdert u die opnieuw, de LED is nu geactiveerd. Zet de jumper weer in zijn oorspronkelijke positie.

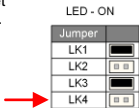

6. LED deactiveren

Steek een jumper op LK1. Sluit **LK4** met een jumper kort tot de LED permanent knippert. Daarna verwijdert u die opnieuw, de LED is nu gedeactiveerd. Zet de jumper weer in zijn oorspronkelijke positie.

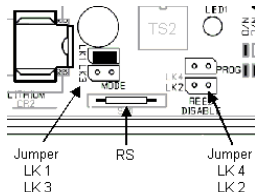
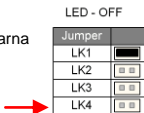

7. Inlezen van de zones:

Zorg ervoor dat de **Secvest** (ontvanger) zich telkens in de inleesmodus bevindt. Gebruik een **draadloze universele module** (draadloze uitbreiding), dan houd u de signaal-LED „**SL**” van de melder max. 50 mm boven de IR-ontvanger en leest u de zones in, zoals onderaan beschreven.



Op de laatste pagina's bevinden zich de mogelijke configuraties van de verschillende zones. U kunt dit draadloze magneetcontact ook als draadloze module gebruiken.

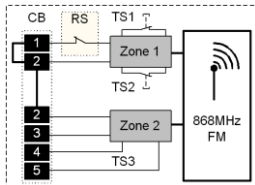

8. Inlezen van de zone 1

Houd het wandlostrekcontact „**TS2**”, in gedemonteerde toestand ook het dekselcontact „**TS1**” ingedrukt.

Open één van deze contacten tot de ontvanger de ontvangst bevestigt.

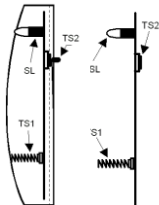

9. Inlezen van de zone 2

(indien vereist)

Sluit de aansluiting „**TAMP**” met een geleiderbrug aan de aansluitklem contact **4** en **5**.

Open en sluit de verbinding „**TAMP**” tot de ontvanger de ontvangst bevestigt.

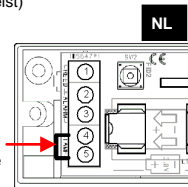



Let op!

10. Monteer de melder:

- **niet** op of in de buurt van metalen vlakken!
- **niet** onder 1 m van gas-, water- en stroomleidingen!
- **niet** in de buurt van elektrische apparaten, bijv. computers, kopieerapparaten of andere zenders!

11. Reikwijdte:

De reikwijdte is afhankelijk van de omgevingsomstandigheden. Bevestig daarom de melder bij wijze van proef met dubbelzijdige plakband en activeer bij wijze van test een alarm. Werd dit signaal door de **Secvest** niet ontvangen, dan test u de melder op een andere plaats. De signaalsterkte mag de **waarde 3** niet onderschreiden. Controle met de **Secvest**: Ga naar het programmeermenu → Test → Meldersignaal

12. Montageplaats:

Optimale montageplaats voor de draadloze openingsmelder is de bovenste hoek van uw raam-/deurkozijn. Zorg ervoor dat u de melder op een effen oppervlak installeert, zodat het wandlostrekcontact TS2 (zie inlezen zone 1) schakelt.



Weergave: **Secvest**

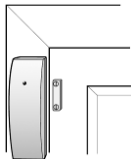

NL

13. Montage:

Verwijder de printplaat uit het huis. Schroef „MS” lossen, e printplaat eruit tillen.

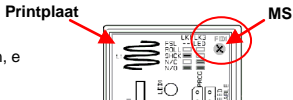

	Bevestig de melder en de magneethouder centraal t.o.v. de markering „3” op max. 10 mm afstand.
--	--

Daarna gebruikt u de bodemplaat van de melder en van de magneethouder om de bevestigingsgaten 1, 4 en 6, 7 te markeren.

Gebruik de lenskopschroeven „A” voor de **melder** en de platkopschroeven „B” voor de **magneethouder**.

Zorg ervoor dat het wandlostrekcontact „2” naar binnen beweegt.

Kabelopening „5” voor externe melders, max. 10 meter aansluitkabel.

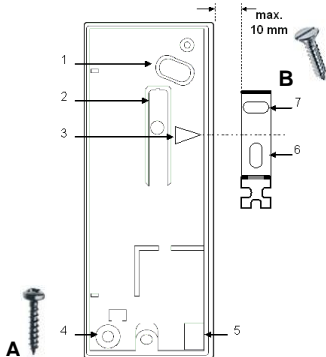

14. Configuraties:

Afkortingen	Beschrijving	Afkortingen	Beschrijving
CB	Aansluitklem	TS1 - 2	Interne sabotagecontacten
RS	Reed schakelaar	eTS3	Extern sabotagecontact
NC	Normaal gesloten	eS1 - 2	Externe schakelcontacten
NO	Normaal open		



Gebruik alleen de zone 2 van de melder, dan zijn de interne sabotagecontacten TS1-2 gedeactiveerd.

Afb. 1

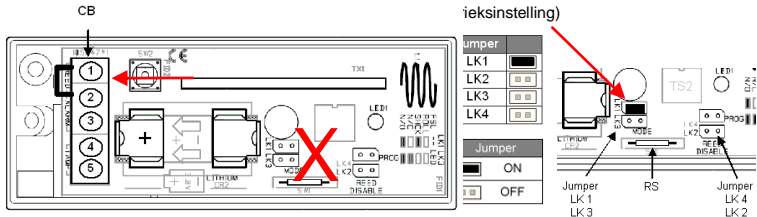

Prefazione

Egregio cliente,

la ringraziamo per aver acquistato questo radiorilevatore di apertura. Questo apparecchio è stato realizzato secondo gli attuali standard della tecnica. E risponde ai requisiti richiesti dalle vigenti direttive europee e nazionali.

“ABUS Security-Center GmbH & Co. KG dichiara con la presente che l'apparecchio con il numero di articolo FUMK50000W/B; FUMK50010W/B è conforme ai requisiti essenziali e alle disposizioni pertinenti relative alla/e direttiva 1999/5/EG. La dichiarazione di conformità è disponibile al seguente indirizzo:

ABUS Security-Center GmbH & Co. KG
Linker Kreuthweg 5
86444 Affing
GERMANY”



Attenzione!

Osservare le indicazioni e le avvertenze fornite nelle presenti istruzioni! La mancata osservanza delle presenti istruzioni comporta l'annullamento della garanzia. È esclusa la responsabilità per danni indiretti.

Il prodotto nella non deve essere modificato e/o ricostruito.





Avvertenza batteria

Il dispositivo è alimentato da una batteria al litio da 3 V con tensione continua.
Per garantire una lunga durata e per evitare incendi e lesioni rispettare la seguente avvertenze:

- Non smaltire le batterie con i rifiuti domestici
- Le batterie non vanno esposte direttamente a fonti di calore o raggi solari né conservate in un luogo con temperature troppo elevate
- La batteria non va bruciata
- La batteria non deve venire a contatto con l'acqua
- La batteria non va smontata, forata o danneggiata
- I contatti della batteria non vanno cortocircuitati
- Tenere le batterie lontano dalla portata dei bambini
- Le batterie non sono ricaricabili

1. Fornitura:

- 1 manuale di istruzioni per l'installazione
- 1 magnete
- 1 batteria CR2 al litio da 3 V
- 1 supporto magnetico
- 1 rilevatore d'apertura
- 2 viti a testa esagonale (supporto magnetico)
- 2 viti a testa cilindrica (rilevatore)
- 4 piastre distanziatrici magnete
- 2 piastre distanziatrici rilevatore
- 4 ponticelli (jumper) sul sistema elettronico

3. Messa in funzione:

Aprire l'alloggiamento allentando la vite, quindi rimuovere il coperchio.

2. Dati tecnici:

Alimentazione di tensione:	3V Li/MnO ₂
Tipo batteria:	CR2
Corrente assorbita:	0,03 A
Frequenza:	868,6625 MHz/FM
Peso:	ca. 53 g
Ingombro LxAxP mm:	33x89x29
Tempo di carica della batteria:	fino a 36 mesi
Classe ambientale:	I (-10-+55 °C)
Grado di sicurezza:	II
N. INCERT:	C0160194
Materiale alloggiamento:	ABS



Attenzione!

Rispettare la polarità!

Inserire la batteria nel radiorilevatore d'apertura.

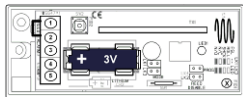

4. Segnale LED:

Stato di esercizio	Segnale
Modalità di funzionamento	Nessun segnale
Invia / Modalità programmatore IR	4 lampeggiamenti
Modalità programmatore rilevatore interno	Lampeggiamento continuo

Segnale LED

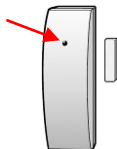

5. Attivazione LED:

Inserire un jumper su LK1e LK3. Collegare **LK4** con un jumper creando un cortocircuito, fintanto che il LED lampeggia in modo continuo. Dopodiché rimuoverlo nuovamente, e a questo punto il LED è attivato. Ripristinare la posizione originaria del jumper.

LED - ON

Jumper	
LK1	■
LK2	□ □
LK3	■
LK4	□ □



6. Disattivazione del LED:

Inserire un jumper su LK1. Collegare **LK4** con un jumper creando un cortocircuito, fintanto che il LED lampeggia in modo continuo. Dopodiché rimuoverlo nuovamente, e a questo punto il LED è disattivato. Ripristinare la posizione originaria del jumper.

LED - OFF

Jumper	
LK1	■
LK2	□ □
LK3	□ □
LK4	□ □

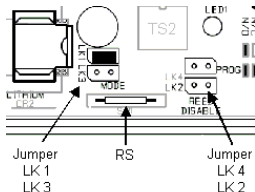

7. Inizializzazione delle zone:

Assicurarsi che il **Secvest** (ricevitore) si trovi nella rispettiva modalità di inizializzazione. Utilizzare un **modulo universale radio** (ampliamento radio), quindi mantenere il segnale LED "SL" del rilevatore al massimo 50 mm al disopra del ricevitore IR e inizializzare le zone descritte in seguito.



Nell'ultima pagina sono esposte le possibili configurazioni delle singole zone. È possibile utilizzare questo contatto magnetico via radio anche come modulo radio.

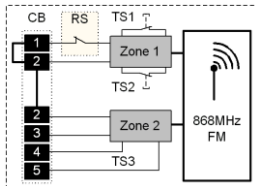

8. Inizializzazione della zona 1:

Mantenere premuto il contatto antidistacco a parete "TS2" e, in stato di disassemblato, anche il contatto parete-soffitto "TS1".

Aprire uno di questi contatti finché il ricevitore non ha confermato la ricezione.

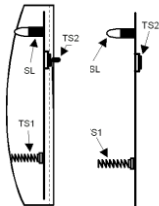

9. Inizializzazione della zona 2

(se necessario)

Chiudere il collegamento "TAMP" con un ponticello in corrispondenza del morsetto contatto 4 e 5.

Aprire e chiudere la connessione "TAMP" finché il ricevitore non ha confermato la ricezione.

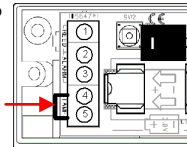

Attenzione!

10. Montare il rilevatore

- **non** su superfici metalliche o in prossimità di esse!
- **non** a meno di 1m di distanza da linee elettriche e tubature per acqua e gas!
- **non** nelle vicinanze di apparecchi elettrici, ad es. computer, fotocopiatrici o altri trasmettitori!

11. Portata:

La portata dipende dalle condizioni ambientali. Effettuare un fissaggio provvisorio del rilevatore mediante nastro biadesivo e far scattare un allarme di prova. Nel caso in cui il **Secvest** non dovesse ricevere il segnale, testare il rilevatore in un luogo diverso. La potenza del segnale non dovrebbe essere inferiore al **valore 3**. Verifica col **Secvest**: spostarsi su Modalità installatore → Test → Segnale rilevatore

12. Punto di montaggio:

Il punto ottimale per montaggio del radiorilevatore d'apertura è l'angolo superiore del telaio della finestra o della porta. Fare attenzione al fatto che il rilevatore venga installato su una superficie piana, in modo che il contatto antidistacco a parete (vedi inizializzazione zona 1) venga fatto scattare.



Indicatore: **Secvest 868**

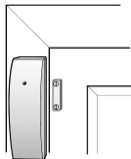

13. Montaggio:

Rimuovere la scheda dall'alloggiamento. Allentare la vite "MS" ed estrarre la piastra.

Scheda a circuito stampato

MS



	Fissare il rilevatore e il supporto magnetico al centro in corrispondenza della marcatura "3" ad una distanza al massimo pari a 10 mm.
---	--

Dopodiché utilizzare la piastra di base del rilevatore e del supporto magnetico per contrassegnare i fori di fissaggio 1, 4 e 6, 7.

Utilizzare le viti a testa cilindrica "A" per il **rilevatore** e le viti a testa esagonale "B" per il **supporto magnetico**.

Fare attenzione che il contatto antidistacco a parete "2" si muova verso l'interno.

Apertura per cavo "5" per rilevatori esterni, cavo di collegamento max. 10 metri.

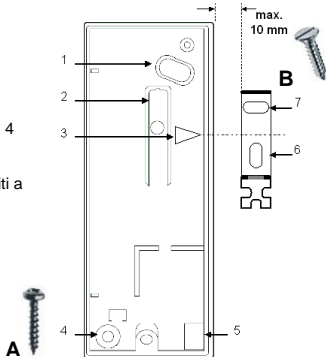

14. Configurazioni:

Abbreviazioni	Descrizione	Abbreviazioni	Descrizione
CB	Morsetto	TS1 - 2	Contatto antisabotaggio interno
RS	Interruttore Reed	eTS3	Contatto antisabotaggio esterno
NC	Normalmente chiuso	eS1 - 2	Contatti di interruzione esterni
NO	Normalmente aperto		



Utilizzare solo la zona 2 del rilevatore; in tal modo i contatti antisabotaggio interni TS1-2 sono disattivati.

III. 1

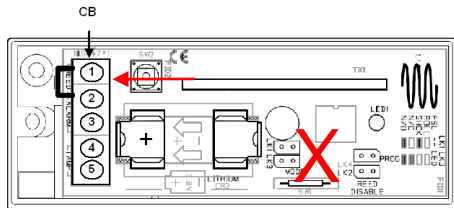

Configurazione di default)

Jumper	Configurazione
LK1	<input checked="" type="checkbox"/>
LK2	<input type="checkbox"/>
LK3	<input type="checkbox"/>
LK4	<input type="checkbox"/>

Jumper	Configurazione
RS	<input checked="" type="checkbox"/>
REED DISABLE	<input type="checkbox"/>

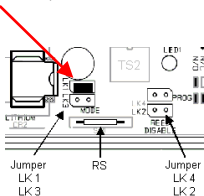

Forord

Kære kunde.

Tak, fordi du har valgt at købe denne trådløse åbningsmelder. Apparatet er konstrueret i overensstemmelse med den nyeste tekniske udvikling. Det opfylder kravene i de gældende europæiske og nationale direktiver.

"Hermed erklærer ABUS Security-Center GmbH & Co. KG, at apparatet med artikelnummeret FUMK50000W/B; FUMK50010W/B er i overensstemmelse med de grundlæggende krav og de gældende bestemmelser i direktivet 1999/5/EG. Overensstemmelseserklæringen kan rekvireres på følgende adresse:

ABUS Security-Center GmbH & Co. KG
Linker Kreuthweg 5
86444 Affing
GERMANY"



Vigtigt !

Overhold anvisningerne og henvisningerne i denne vejledning! Hvis du ikke overholder denne vejledning, bortfalder dit garantikrav! For følgeskader påtager vi os intet ansvar!
Produktet må ikke forandres eller ombygges.



Batteriadvarelsenhvisninger

Apparatet forsynes med jævnspænding af et 3 V-litiumbatteri. For at garantere en lang levetid og undgå brande og kvæstelser skal du overholde følgende henvisninger:

- Batteriet må ikke bortskaffes med husholdningsaffaldet.
- Batteriet må ikke udsættes for en varmekilde eller direkte solstråling og må ikke opbevares på et sted med meget høje temperaturer.
- Batteriet må ikke brændes.
- Batteriet må ikke komme i berøring med vand.
- Batteriet må ikke skilles ad, stikkes i eller beskadiges.
- Batterikontakterne må ikke kortsluttes.
- Batteriet må ikke komme i hænderne på små børn.
- Batteriet er ikke genopladeligt.

1. Leveringsomfang:

- 1 x installationsvejledning
- 1 x magnet
- 1 x batteri CR2 3 V lithium
- 1 x magnetholder
- 1 x åbningsmelder
- 2 x forsænkede skruer (magnetholder)
- 2 x rundhovedede skruer (melder)
- 4 x magnet afstandsplader
- 2 x melder afstandsplader
- 4 x jumpere på elektronik

3. Idriftsættelse:

Åbn huset ved at skrue skruen ud og derefter fjerne dækslet.

2. Tekniske data:

Spændingsforsyning:	3 V Li/MnO ₂
Batteritype:	CR2
Strømforbrug:	0,03 A
Frekvens:	868,6625 MHz / FM
Vægt:	ca. 53 g
Mål BxHxD mm:	33x89x29
Batterilevetid:	op til 36 måneder
Miljøklasse:	I (-10 - +55 °C)
Sikkerhedsgrad:	II
INCERT-nr.:	C0160194
Kabinetmateriale:	ABS



Vigtigt !

Vær opmærksom på polariteten!

Sæt batteriet i den trådløse åbningsmelder.

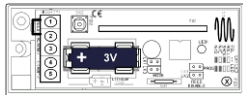

4. Signal-LED

Driftstilstand	Signal
Driftsmodus	Intet signal
Send / programmeringsmenu IR	4 x blink
Programmeringsmenu melder intern	Kontinuerligt blink

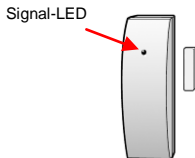

5. Aktivering af LED

Sæt en jumper på LK1 og LK3. Kortslut **LK4** med en jumper, indtil LED'en blinker kontinuerligt. Fjern den derefter igen, LED'en er nu aktiv. Stil jumperen på plads igen i dens oprindelige position.

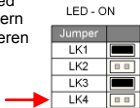

6. Deaktivering af LED

Sæt en jumper på LK1. Kortslut **LK4** med en jumper, indtil LED'en blinker kontinuerligt. Fjern den derefter igen, LED'en er nu deaktiveret. Stil jumperen på plads igen i dens oprindelige position.

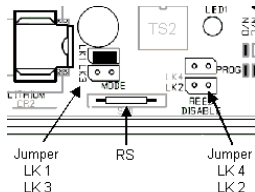
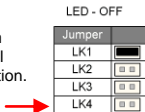

7. Indlæring af zonerne:

Kontrollér, at **Secvest** (modtager) befinder sig i indlæringsfunktionen. Anvend et **trådløst universalmodul** (trådløs udvidelse), hold derefter signal-LED'en "**SL**" til melderer maks. 50 mm over IR-modtageren, og indlær zonerne som beskrevet forneden.



På de sidste sider findes de mulige konfigurationer af de enkelte zoner. Du kan også bruge denne trådløse magnetkontakt som trådløst modul.

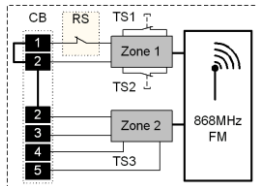

8. Indlæring af zone 1

Hold vægafrivningskontakten "**TS2**" og dækselkontakten "**TS1**" når afmonteret trykket nede.

Åbn en af disse kontakter, indtil modtageren bekræfter modtagelsen.

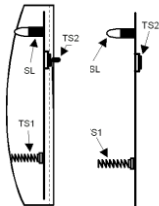

9. Indlæring af zone 2

(hvis nødvendigt)

Forbind tilslutningen "**TAMP**" med en jumper på tilslutningsklemmen kontakt **4** og **5**.

Åbn og luk forbindelsen "**TAMP**", indtil modtageren bekræfter modtagelsen.

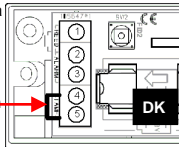



Vigtigt!

10. Montering af melderne:

- **ikke** på eller i nærheden af metalflader!
- **ikke** under 1 m afstand til gas-, vand-, og strømledninger!
- **ikke** i nærheden af elektrisk udstyr, f.eks. computere, kopimaskiner eller andre sendere!

11. Rækkevidde:

Rækkevidden afhænger af omgivelsesbetingelserne. Fastgør derfor melderens forsøgsvist med dobbeltklæbende tape, og udløs en testalarm. Hvis signalet fra **Secvest** ikke blev modtaget, skal du teste melderens på et andet sted. Signalstyrken bør ikke underskride **værdi 3**. Kontrol med **Secvest**: Åbn programmeringsmenuen → Test → Meldersignal

12. Montagedsted:

Optimalt montagedsted for den trådløse åbningsmelder er det øverste hjørne af dit vindue-/dør ramme. Vær opmærksom på, at melderens installeres på en plan flade, så vægafrivningskontakten TS2 (se Indlæring af zone 1) kobler.



Visning: **Secvest 868**

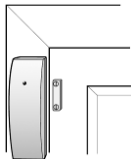

13. Montage:

Fjern printkortet fra huset. Løsn skruen "MS", tag printkortet ud.

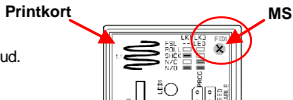

Fastgør melderens og magnetholderens bundplade for at markere "3" med maks.10 mm afstand.

Derefter skal du benytte melderens og magnetholderens bundplade for at markere fastgørelseshullerne 1, 4 og 6, 7.

Anvend de rundhovedede skruer "A" til **melderens** og de forsænkede skruer "B" til **magnetholderens**.

Vær opmærksom på, at vægafrivningskontakten "2" bevæger sig indad.

Kabelåbning "5" til eksterne meldere, maks. 10 meter tilslutningskabel.

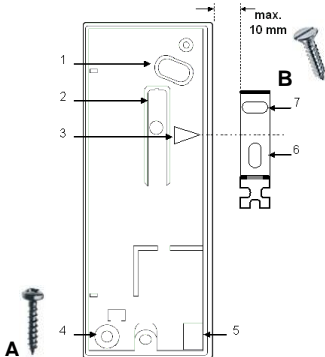

14. Konfigurationer:

Forkortelser	Beskrivelse	Forkortelser	Beskrivelse
CB	Tilslutningsklemme	TS1 - 2	Interne sabotagekontakter
RS	Reed-kontakt	eTS3	Ekstern sabotagekontakt
NC	Normalt lukket	eS1 - 2	Eksterne koblingskontakter
NO	Normalt åben		



Anvend kun melderens zone 2, så er de interne sabotagekontakter TS1-2 deaktiverede.

Fig. 1

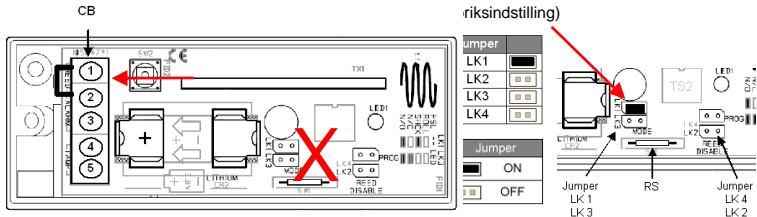

Wstęp

Szanowna Klientko, Szanowny Kliencie,

Dziękujemy za zakup radiowej czujki otwarcia. Urządzenie jest skonstruowane zgodnie z aktualnym stanem techniki. Spełnia ono wymagania obowiązujących norm europejskich i krajowych.

„Niniejszym firma ABUS Security-Center GmbH & Co. KG oświadcza, że urządzenie o numerze artykułu FUMK50000W/B; FUMK50010W/B jest zgodna z podstawowymi wymaganiami oraz odnośnymi postanowieniami dyrektyw 1999/5/EG. Deklarację zgodności można uzyskać pod poniższym adresem:

ABUS Security-Center GmbH & Co. KG
Linker Kreuthweg 5
86444 Affing
GERMANY"



Uwaga!

Przestrzegaj wskazówek zawartych w niniejszej instrukcji! Nieprzestrzeganie instrukcji pociąga za sobą utratę praw gwarancyjnych! Nie ponosimy odpowiedzialności cywilnej za szkody następcze! Produktu nie wolno zmieniać ani przebudowywać.



Ostrzeżenia dotyczące baterii

Urządzenie jest zasilane napięciem stałym przez baterię litową 3 V.

Aby zapewnić długą żywotność baterii i uniknąć pożarów oraz urazów, przestrzegaj następujących wskazówek.

- Nie wyrzucaj zużytych baterii razem z odpadami domowymi.
- Bateria nie może być narażona na działanie źródeł ciepła lub promieniowania słonecznego ani przechowywana w miejscach o bardzo wysokiej temperaturze.
- Baterii nie wolno spalać.
- Bateria nie może kontaktować się z wodą.
- Baterii nie wolno rozbierać, nakłuwać ani uszkadzać.
- Nie wolno zwierać styków baterii.
- Należy zabezpieczyć baterię przed dostępem małych dzieci.
- Bateria nie może być ładowana.

1. Zakres dostawy

- 1 x instrukcja instalacji
- 1 x elektromagnes
- 1 x bateria litowa CR2 3 V
- 1 x uchwyt elektromagnesu
- 1 x czujka otwarcia
- 2 x śruby z łbem wpuszczanym (do uchwytu elektromagnetycznego)
- 2 x śruby z łbem soczewkowym (do czujki)
- 4 x płytki dystansowe do elektromagnesu
- 2 x płytki dystansowe do czujki
- 4 x zworki na płytce elektronicznej

3. Uruchomienie

Otwórz obudowę, odkręcając śrubę a następnie zdejmują pokrywkę.

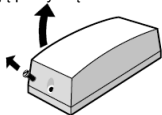

2. Dane techniczne

Zasilanie napięciowe	3 V Li/MnO ₂
Typ baterii	CR2
Pobór prądu	0,03 A
Częstotliwość	868,6625 MHz/FM
Masa	ok. 53 g
Wymiary S x W x G mm	33 x 89 x 29
Żywotność baterii	do 36 miesięcy
Klasa ochrony środowiska	I (-10 ±55 °C)
Poziom bezpieczeństwa	II
Nr INCERT	C0160194
Materiał obudowy	ABS



Uwaga!

Uwzględnij prawidłową

Włóż baterie do radiowej czujki otwarcia.

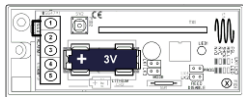

4. Sygnalizacyjna dioda LED

Stan pracy	Sygnal
Tryb pracy	Brak sygnału
Nadawanie/Tryb programowania IR	4 x mignięcie
Tryb programowania czujki wewn.	Ciągłe miganie

Sygnalizacyjna dioda



5. Uaktywnianie diody LED

Założ zwórkę na LK1 i LK3. Zewrzyj **LK4** zwórką tak, aby dioda LED ciągle migiała. Następnie zdejmij ją, dioda LED jest teraz aktywna. Przywróć początkowe położenie zworki.

LED - ON

Jumper	
LK1	■
LK2	□□
LK3	■
LK4	□□



6. Wyłączanie diody LED

Założ zwórkę na LK1. Zewrzyj **LK4** zwórką tak, aby dioda LED ciągle migiała. Następnie zdejmij ją, dioda LED jest teraz nieaktywna. Przywróć początkowe położenie zworki.

LED - OFF

Jumper	
LK1	■
LK2	□□
LK3	□□
LK4	□□

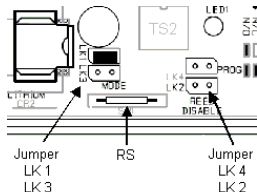

7. Programowanie stref

Upewnij się, czy centrala **Secvest** (odbiornik) znajduje się w trybie programowania. Jeżeli używasz **radiowego modułu uniwersalnego** (rozszerzenie radiowe), przytrzymaj sygnalizacyjną diodę LED „SL” czujki maks. 50 mm nad odbiornikiem IR i zaprogramuj strefy wg poniższego opisu.



Na następnych stronach opisane są możliwe konfiguracje poszczególnych stref. Radiowy zestaw elektromagnetyczny można wykorzystać także jako moduł radiowy.

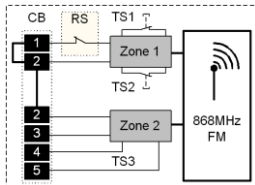

8. Programowanie strefy 1

Przytrzymaj zestaw oderwania od ściany „TS2” w stanie wymontowanym dociśnięty do zestawu pokrywy „TS1”.

Rozwieraj jeden z tych zestawów aż odbiornik potwierdzi odbiór.

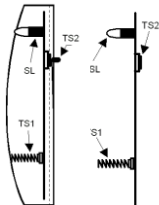

9. Programowanie strefy 2

(w razie potrzeby)

Podłącz złącze „TAMP” mostkiem drutowym do zacisku przyłączeniowego zestaw 4 i 5.

Rozwieraj i zwieraj połączenie „TAMP”, aż odbiornik potwierdzi odbiór.

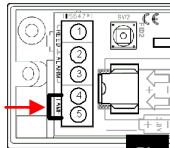



Uwaga!

10. Nie montuj czujki:

- na lub w pobliżu powierzchni metalowych!
- w odległości mniejszej niż 1 m od przewodów gazowych, wodnych i elektrycznych!
- w pobliżu urządzeń elektrycznych np.,

11. Zasięg

Zasięg zależy od warunków otoczenia. Dlatego przymocuj czujkę prowizorycznie dwustronną taśmą samoprzylepną i wypróbuj, wyzwalając alarm. Jeżeli centrala **Secvest** nie odbierze sygnału, spróbuj zainstalować czujkę w innym miejscu. Moc sygnału **nie powinna być niższa od wartości 3**. Kontrola z centrali **Secvest**: przejdź do Trybu instalatora → Test → Sygnał czujki

12. Miejsce zamontowania

Optymalne miejsce zamontowania radiowej czujki otwarcia to górny róg ramy okna/drzwi. Dopilnuj, aby czujka została zainstalowana na płaskiej powierzchni, aby działał zestyk oderwania od ściany TS2 (patrz Programowanie strefy 1).



Wskaźnik: **Secvest**

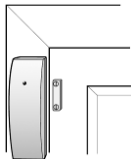

13. Montaż

Wyjmij płytkę elektroniczną z obudowy. Wykręć śrubę „MS”, wyjmij płytkę.

Płytką drukowaną

MS



Zamocuj czujkę i uchwyt elektromagnesu centrycznie względem oznaczenia „3” w odległości maks. 10 mm.

Następnie użyj podstawy czujki i uchwytu elektromagnetycznego do zaznaczenia otworów do wywiercenia 1, 4 i 6, 7.

Użyj śrub z łbem soczewkowym „A” do czujki i śrub z łbem wpuszczanym „B” do uchwytu elektromagnesu.

Zwróć uwagę, aby zestaw oderwania od ściany „2” poruszał się do wewnątrz.

Otwór na kabel „5” do czujki zewnętrznej, maks. 10 metrów kabla przyłączeniowego.

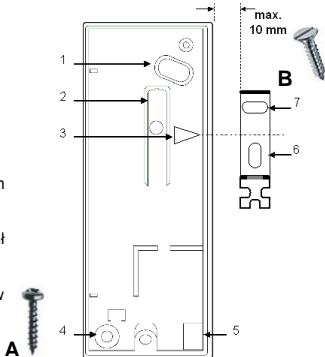

14. Konfiguracje

Skróty	Opis	Skróty	Opis
CB	Zacisk przyłączeniowy	TS1- 2	Wewnętrzne zestyki sabotażowe
RS	Przełącznik kontaktronowy	eTS3	Zewnętrzny zestyk sabotażowy
NC	Normalnie zamknięty	eS1- 2	Zewnętrzne zestyki przełączające
NO	Normalnie otwarty		



Jeżeli wykorzystujesz tylko strefę 2 czujki, wewnętrzne zestyki sabotażowe TS1-2 są nieaktywne.

Rys. 1

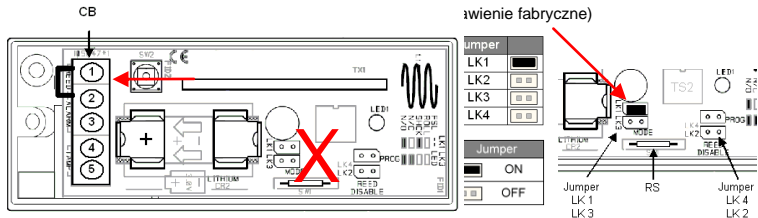

Fig.2 Zone 1 - 1 x NC / RS + 1 x NC / eS1

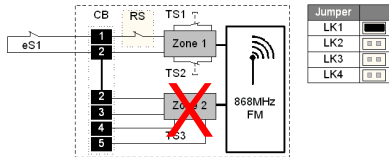

Fig.3 Zone 1 - 1 x NC / eS1

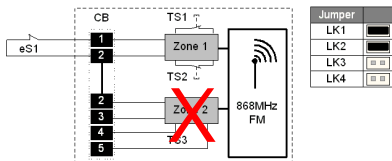

Fig.4 Zone 2 - 1 x NC / eS2

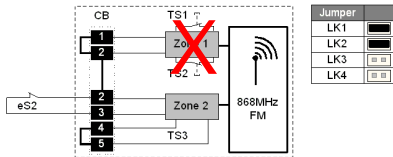

Fig.5 Zone 2 - 1 x NO / eS2

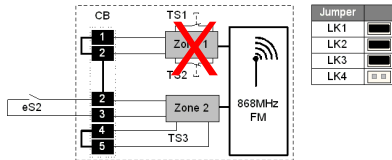

Fig.6 Zone 2 - 1 x NC / eTS3

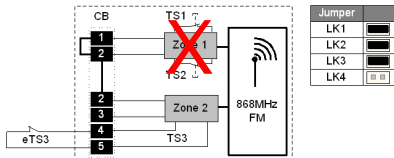

Fig.7 Zone 2 - 1 x NO / eS2 + 1 NC / eTS

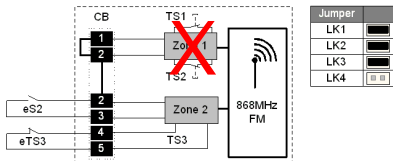

Fig.8 Zone 2 - 1 x NC / eS2 + 1 NC / eTS

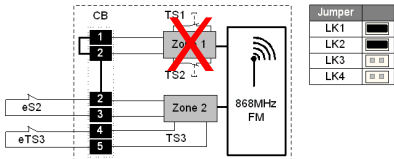

Fig.9 Zone 1 - 1 x NC / RS
Zone 2 - 1 x NO / eS2

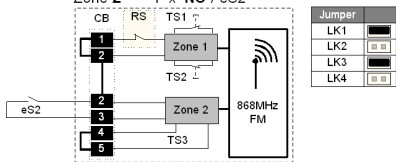

Fig.10 Zone 1 - 1 x NC / RS + 1 x NC / eS1
 Zone 2 - 1 x NO / eS2

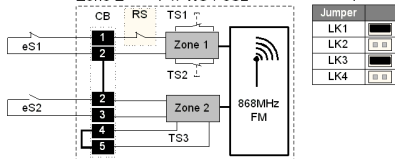

Fig.11 Zone 1 - 1 x NC / RS + 1 x NC / eS1
 Zone 2 - 1 x NC / eS2

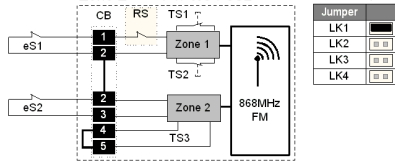

Fig.12 Zone 1 - 1 x NC / RS + 1 x NC / eS1
 Zone 2 - 1 x NO / eS2 + 1 x NC / eTS3

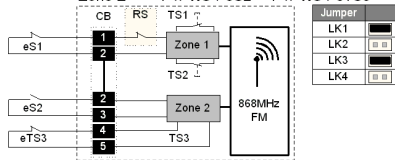
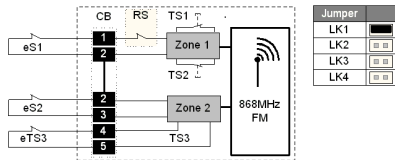

Fig.13 Zone 1 - 1 x NC / RS + 1 x NC / eS1
 Zone 2 - 1 x NC / eS2 + 1 x NC / eTS3





FUMK50010W/

Funköffnungsmelder
Installationsanleitung

Radio-controlled opening detector
Installation Guide

Détecteur d'ouverture sans fil
Instructions d'installation

Draadloze openingsmelder
Installatie-instructies

Radorilevatore di apertura
Guida di installazione

Trådløs åbningsmelder
Installationsvejledning

Radiowa czujka otwarcia
Instrukcja instalacji

D

GB

FR

NL

I

DK

PL



BOM - No. 12443335

FUMK50010W/B

Melder als Funkmodul nutzen

Sie können diesen Funkmagnetkontakt auch als Funkmodul nutzen.

1. Schließen Sie den Steckbrückenanschluss LK2 (Fig.1, Pos.2), um den internen Magnetkontakt zu deaktivieren. Schließen Sie die externen Melder an den Klemmen des Schraubklemmblocks an und lernen sie ein, siehe „Externe Kontakte anschließen“ und „Externe Kontakte einlernen“.

Externe Kontakte einlernen

Die externen Kontakte des Funköffnungsmelders werden auf eine extra Zone der Zentrale eingelernt:

1. Setzen Sie Ihre Funkzentrale in den Lernmodus. Beachten Sie die Anleitung Ihrer Funkzentrale.
 - 1.1. Verbinden Sie die beiden Schraubklemmen am Schraubklemmblock mit einem 2K2 Widerstand.
 - 1.2. Entfernen Sie den Widerstand wieder, um eine Funk Übertragung auszulösen.
- ODER:
 - 1.3. Verbinden Sie den externen Kontakt mit einem Melder und öffnen Sie den Sabotageschutz.
 - 1.4. Vergewissern Sie sich, dass die Alarmzentrale den Melder erkannt hat.

Externe Kontakte anschließen

Sie können externe Kontakte über DEOL an diesen Funk-Öffnungsmelder anschließen. Bei mehreren Geräten, müssen diese in Reihe geschaltet sein. Die Kabellänge sollte 10 m nicht überschreiten. Schließen Sie die externen Geräte an die Schraubklemmen auf der Platine an, Beachten Sie auch die Widerstandswerte.

LED aktivieren / deaktivieren

Brücken Sie den Steckbrücken-Anschluss LK3 um die LED zu aktivieren. Entfernen Sie die Brücke, um sie zu deaktivieren.

LED	Blinkend: Programmiermodus 4x blinken: Senden Aus: Normal
LK2	Interner Kontakt <div style="display: inline-block; vertical-align: middle;"> <div style="border: 1px solid black; width: 10px; height: 10px; display: inline-block; margin-right: 5px;"></div> Aus <div style="border: 1px solid black; width: 10px; height: 10px; display: inline-block; margin-right: 5px; border: 1px dashed black;"></div> Ein </div>
LK3	LED <div style="display: inline-block; vertical-align: middle;"> <div style="border: 1px solid black; width: 10px; height: 10px; display: inline-block; margin-right: 5px;"></div> Ein <div style="border: 1px solid black; width: 10px; height: 10px; display: inline-block; margin-right: 5px; border: 1px dashed black;"></div> Aus </div>

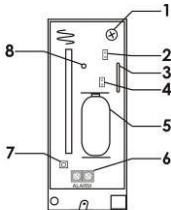

Nr.	Bezeichnung
1	Befestigungsschraube
2	Steckbrückenanschluss LK2
3	Magnetschalter
4	Steckbrückenanschluss LK3
5	Batterie
6	Schraubklemmblock
7	Sabotageschutz, Deckel
8	LED

D

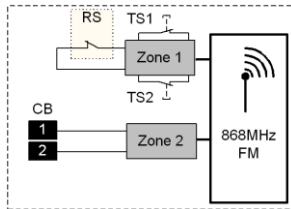
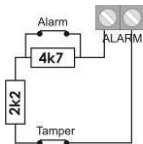
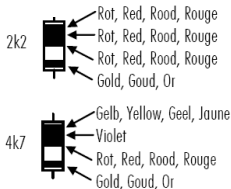

Using detectors as wireless modules

This wireless magnet contact can also be used as a wireless module.

1. Close the jumper connection LK2 (Fig. 1, Pos. 2) to deactivate the internal magnet contact. Connect the external detectors to the clamps of the screw clamp block and train them (see "Connecting external contacts" and "Training external contacts").

Training external contacts

The external contacts of the wireless opening detector are trained for an extra zone of the system:

1. Switch your wireless centre to learn mode. Observe the system instructions.
 - 1.1. Connect both screw clamps on the screw clamp block with a 2K2 resistor.
 - 1.2. Remove the resistor to trigger wireless transmission.
- OR:
 - 1.3. Connect the external contact to a detector and open the tamper protection.
 - 1.4. Check that the alarm centre has recognised the detector.

Connecting external contacts

External contacts can be connected via DEOL to this opening detector.





Two or more devices must be connected in series.

The cable length must not exceed 10 metres.

Connect the external devices to the screw clamps on the PCB. Pay attention to the resistance values.

Activating/deactivating LEDs

Connect the jumper to contact LK3 to activate the LED. Remove the jumper to deactivate it.

LED	Flashing: Program mode 4x flashing: Transmit Off: Normal
LK2	Internal contact  Off  On
LK3	LED  On  Off

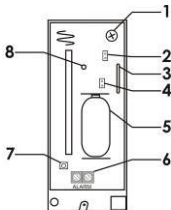

No.	Name
1	Fixing screw
2	Jumper connection LK2
3	Magnet switch
4	Jumper connection LK3
5	Battery
6	Screw clamp block
7	Tamper protection, cover
8	LED

GB

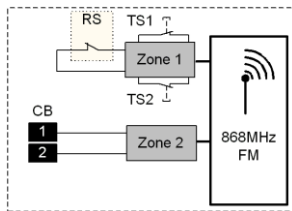
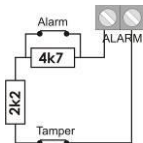
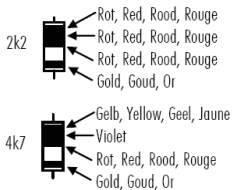

Utilisation du détecteur en tant que module radio

Ce contact magnétique sans fil peut également être utilisé en tant que module radio.

1. Fermez la borne du strap enfichable LK2 (fig. 1, pos. 2) pour désactiver le contact magnétique interne.

Reliez les détecteurs externes aux bornes à vis de la barrette et procédez à leur apprentissage, voir « Raccordement de contacts externes » et « Apprentissage de contacts externes ».

Apprentissage de contacts externes

L'apprentissage des contacts externes du détecteur d'ouverture sans fil a lieu sur une zone particulière de la centrale :

1. Mettez la centrale d'alarme sans fil en mode d'apprentissage. Tenez compte du mode d'emploi de la centrale d'alarme sans fil.

1.1. Raccordez les deux bornes à vis à la barrette à bornes à l'aide d'une résistance de 2,2 kilohms.

1.2. Retirez de nouveau la résistance pour déclencher un envoi de signal radio.

OU :

1.3. Reliez le contact externe à un détecteur et ouvrez la protection anti-sabotage.

1.4. Assurez-vous que la centrale d'alarme ait détecté le détecteur.

Raccordement de contacts externes





Le raccordement de contacts externes à ce détecteur d'ouverture sans fil est possible par DEOL. En présence de plusieurs appareils, ces derniers doivent être branchés en série.

La longueur de câble ne doit pas dépasser 10 m.

Raccordez les appareils externes aux bornes à vis sur la platine. Tenez également compte des résistances.

Activation/désactivation de DEL

Shuntez LK3 pour activer la DEL. Retirer le cavalier pour la désactiver.

EL	Clignotement : mode de programmation Clignotement quadruple : envoi Eteinte : normal
LK2	Contact interne  Désactivé  Activé
LK3	DEL  Activé  Désactivé

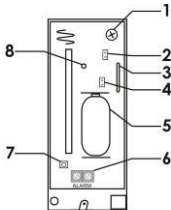

N°	Désignation
1	Vis de fixation
2	Connexion de strap enfichable LK2
3	Contact magnétique
4	Connexion de strap enfichable LK3
5	Pile
6	Barrette de bornes à vis
7	Protection anti-sabotage, couvercle
8	DEL

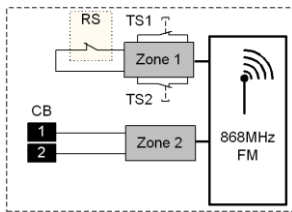
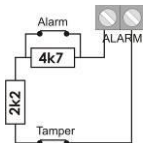
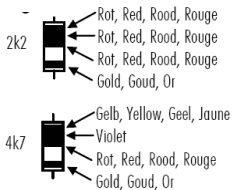

Melder als draadloze module gebruiken

U kunt dit draadloze magneetcontact ook als draadloze module gebruiken.

1. Sluit de geleiderbrugaansluiting LK2 (afb. 1, pos. 2) om het interne magneetcontact te deactiveren.

Sluit de externe melders op de klemmen van het schroefklemblok aan en lees ze in, zie „Externe contacten aansluiten” en „Externe contacten inlezen”.

Externe contacten inlezen

De externe contacten van de draadloze openingsmelder worden op een extra zone van de centrale ingelezen:

1. Zet uw draadloze centrale in de inleesmodus. Neem de handleiding van uw draadloze centrale in acht.

1.1. Verbind de beide klemschroeven op het schroefklemblok met een 2K2 weerstand.

1.2. Verwijder de weerstand weer om een draadloze transmissie te activeren.

OF:

1.3. Verbind het externe contact met een melder en open de bescherming tegen sabotage.

1.4. Controleer of de alarmcentrale de melder herkend heeft.





Externe contacten aansluiten

U kunt externe contacten via DEOL op deze draadloze openingsmelder aansluiten. Bij meerdere apparaten, moeten deze in serie geschakeld zijn. De kabellengte dient niet meer dan 10 m te bedragen.

Sluit de externe apparaten aan de schroefklemmen op de printplaat aan, houd ook rekening met de weerstandswaarden.

LED activeren / deactiveren

Brug de geleiderbrugaansluiting LK3 om de LED te activeren. Verwijder de brug om ze te deactiveren.

LED	Knipperend: Programmeermodus 4 x knipperen: Zenden Uit: Normaal
LK2	Intern contact  Uit  Aan
LK3	LED  Aan  Uit

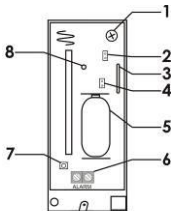

Nr.	Betekenis
1	Bevestigingsschroef
2	Geleiderbrugaansluiting LK2
3	Magneetschakelaar
4	Geleiderbrugaansluiting LK3
5	Batterij
6	Schroefklemblok
7	Bescherming tegen sabotage, deksel
8	LED

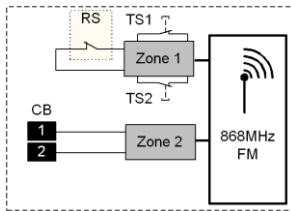
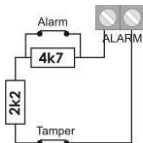
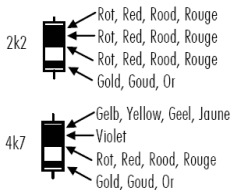

FUMK50010W/B

Utilizzare il rilevatore come modulo radio

È possibile utilizzare questo contatto magnetico via radio anche come modulo radio.

1. Chiudere il collegamento a ponticello LK2 (fig. 1, pos. 2) per disattivare il contatto magnetico.

Collegare i rilevatori esterni ai morsetti del blocco dei morsetti a vite e iniziarli (vedi "Collegamento di contatti esterni" e "Inizializzazione contatti esterni").

Inizializzazione di contatti esterni

I contatti esterni del radorilevatore d'apertura vengono inizializzati in una zona extra della centrale:

1. Impostare la centrale radio in modalità di inizializzazione.

Osservare le istruzioni della centrale di allarme.

1.1. Collegare entrambi i morsetti a vite sul rispettivo blocco con una resistenza di 2K2.

1.2. Rimuovere nuovamente la resistenza per permettere l'emissione di una trasmissione radio.

OPPURE:

1.3. Collegare il contatto esterno con un rilevatore e aprire la protezione antisabotaggio.

1.4. Accertarsi presso la centrale d'allarme che questa abbia riconosciuto il rilevatore.

Collegamento di contatti esterni

È possibile collegare contatti esterni al presente radorilevatore d'apertura attraverso DEOL.





In caso di più apparecchiature, queste devono essere collegate in serie.

La lunghezza del cavo non dovrebbe essere inferiore a 10 m.

Collegare gli apparecchi esterni ai morsetti a vite sulla scheda, osservando anche i valori della resistenza.

Attivazione/disattivazione LED

Collegare il collegamento a ponticello LK3 per attivare il LED. Rimuovere il ponticello per disattivarlo.

LED	lampeggiante : 4x lampeggiamenti : Invia Off.	Modalità programmatore Normale
LK2	Contatto interno	 Off  On
LK3	LED	 On  Off

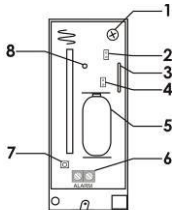

N°	Denominazione
1	Vite di fissaggio
2	Collegamento a ponticello LK2
3	Interruttore con magnete
4	Collegamento a ponticello LK3
5	Batteria
6	Blocco dei morsetti a vite
7	Protezione antisabotaggio, coperchio
8	LED

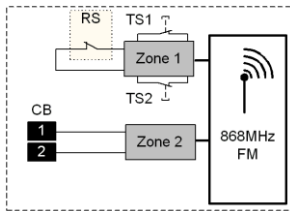
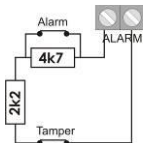
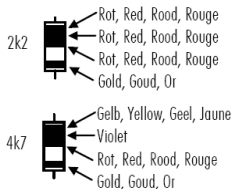

FUMK50010W/B

Burg af melder som trådløst modul

Du kan også bruge denne trådløse magnetkontakt som trådløst modul.

1. Tilslut jumpertilslutning LK2 (fig. 1, pos. 2) for at deaktivere den interne magnetkontakt. Tilslut eksterne meldere til skrueklemmeblokkens klemmer, og indlær dem, se "Tilslutning af eksterne kontakter" og "Indlæring af eksterne kontakter".

Indlæring af eksterne kontakter

Den trådløse åbningsmelders eksterne kontakter indlæres til en af centralens ekstra zoner:

1. Sæt den trådløse central på indlæringsfunktion. Overhold vejledningen til den trådløse central.

1.1. Forbind begge skrueklemmer på skrueklemmeblokken med en 2K2-modstand.

1.2. Fjern modstanden igen for at udløse en trådløs melding. ELLER:

1.3. Forbind den eksterne kontakt med en melder, og åbn sabotagebeskyttelsen.

1.4. Kontrollér, at alarmcentralen har registreret melderens.

Tilslutning af eksterne kontakter





Du kan tilslutte eksterne kontakter via DEOL til denne trådløse åbningsmelder.

Ved flere enheder skal disse tilkobles efter hinanden. Kabellængden bør ikke overskride 10 m.

Tilslut de eksterne enheder til skrueklemmerne på printkortet. Vær også opmærksom på modstandsværdierne.

Aktivering/deaktivering af LED

Slå bro over jumpertilslutning LK3 for at aktivere LED'erne. Fjern broen for at deaktivere dem.

LED	Kontinuerligt blink : Programmeringsmenu 4x blink: Send Off: Normal
LK2	Intern Kontakt  Off  On
LK3	LED  On  Off

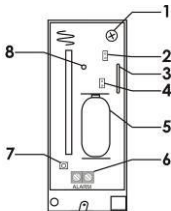

Nr.	Betegnels
1	Fastgørelsesskrue
2	Jumpertilslutning LK2
3	Magnetkontakt
4	Jumpertilslutning LK3
5	Batteri
6	Skrueklemmeblok
7	Sabotagebeskyttelse, dæksel
8	LED

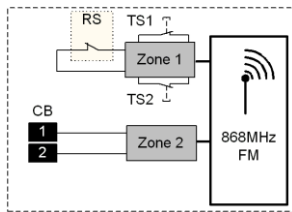
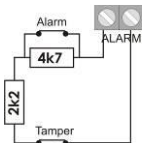
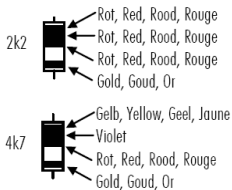

FUMK50010W/B

Wykorzystanie czujki jako modułu radiowego

Radiowy zestyk elektromagnetyczny można wykorzystać także jako moduł radiowy.

1. Podłącz złącze do zworki LK2 (fig. 1, poz. 2), aby wyłączyć wewnętrzny zestyk elektromagnetyczny.

Podłącz czujki zewnętrzne do zacisków bloku zacisków i zaprogramuj je, patrz

„Podłączanie zestyków zewnętrznych” oraz

„Programowanie zestyków

Programowanie zestyków zewnętrznych

Zestyki zewnętrzne radiowej czujki otwarcia programuje się na dodatkową strefę centrali.

1. Ustaw centralę radiową w trybie programowania.

Uwzględnij instrukcję centrali radiowej.

1.1. Połącz oba zaciski śrubowe na bloku zaciskowym z opornikiem 2K2.

1.2. Wyjmij opornik, aby uruchomić transmisję.

ALBO:

1.3. Połącz zestyk zewnętrzny z czujką i rozewrzyj wyłącznik sabotażowy.

1.4. Upewnij się, czy centrala alarmowa wykryła czujkę.

Podłączanie zestyków zewnętrznych

Zestyki zewnętrzne można podłączać przez DEOL do tej radiowej czujki otwarcia.





Jeżeli jest więcej niż jedno urządzenie, należy je połączyć szeregowo.

Długość kabla nie może przekraczać 10 m.

Podłącz urządzenia zewnętrzne do zacisków śrubowych na płycie drukowanej, zwracając

Włączanie/wyłączanie diody LED

Zmostkuj złącze zworki LK3, aby włączyć diodę LED. Usu zworkę, aby wyłączyć diodę LED.

LED	Pulsuje: Tryb programowania Pulsuje 4x: Nadawanie
LK2	Zestyk wewnętrzny  Wył  Wł
LK3	LED  Wł  Wył

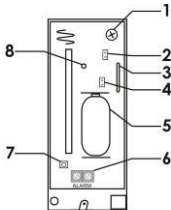

Nr	Oznaczenie
1	Śruba mocująca
2	Złącze do zworki LK2
3	Wyłącznik elektromagnetyczny
4	Złącze do zworki LK3
5	Bateria
6	Blok zacisków
7	Wyłącznik sabotażowy, pokrywa
8	LED

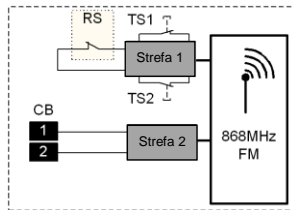
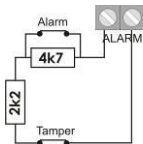
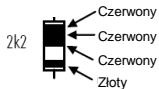

ABUS Security-Center GmbH & Co. KG

86444 Affing

GERMANY

www.abus.com